









Samoa White Gelato

4 • 6 • 7 • 9 • 12 • 120 • 140

Gelato cabinets with ventilated refrigeration. One piece body with ecological polyurethane insulation (HCFC & HFC free), foamed with CO₂. Tempered glass structure. Internal and external tank in plastified sheet. This cabinet can be fitted with a double level of ice-cream containers 4 23/32h.



	REFRIGERANT	R404A
	ENERGY SAVING	Led
	INSTALLATION	Plug-In
	PRODUCT TEMPERATURE	3,2 / 6,8 °F
	DEFROST	Hot gas
	CLIMATIC CLASS	7 [95 °F / 75% R.H.]
	REFRIGERATION	Ventilated
	CLOSING SYSTEM	Tilting panel

STANDARD MODEL INCLUDES:

- Operator side closure with pivoting methacrylate panel system
- Work top in plastified sheet
- Electronic control panel
- Swivel casters with brake
- Led lighting



Piled up double row

5 lt (Large)

14 3/16 x 6 1/2 x 4 23/32h

Samoa White Gelato

4-6-7-9-12

120-140

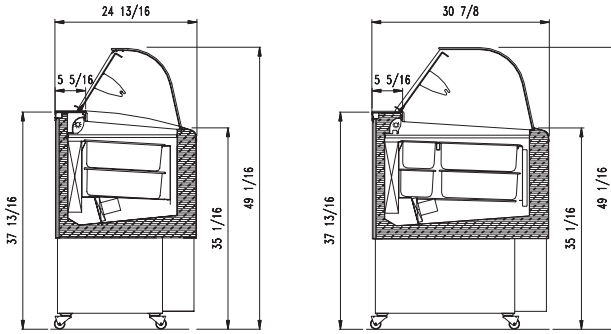

NOTE: The model does not include stainless steel containers.

TECHNICAL FEATURES			4	6	7	9	12	120	140	
External dimensions	Lenght	inch	32 5/16	47 5/8	53 1/8	65 3/16	83 1/4	47 5/8	53 1/8	
Capacity	Gross / Net	liters	218 / 119	339 / 185	383 / 209	478 / 261	621 / 339	459 / 243	518 / 274	
Weight	Net	lb	147,7	218,2	242,5	297,6	379,2	242,5	297,6	
Refrigerant			R404A							
Product temperature		°F	3.2 / 6.8							
Compressor	Type / Q.ty		Hermetic / 1				Hermetic / 2		Hermetic / 1	
Defrost			Hot gas							

STAINLESS STEEL CONTAINERS			4	6	7	9	12	120	140
4,75 lt [Standard]	10 1/4 x 6 3/16 x 6 11/16H		4	6	7	9	12	12	14
5 lt [Large]	14 3/16 x 6 1/2 x 4 23/32H		4 + [4]	6 + [6]	7 + [7]	9 + [9]	12 + [12]	9 + [9]	10 + [10]

ELECTRICAL DATA			4	6	7	9	12	120	140
Power supply			115 / 60 2 pole - 3 wire grounding			220 / 60 / 2 pole - 3 wire grounding			
Nema plug			5-20P			6-15P			
Electrical input	A		14,5	15,6		10,3	16	10	10,3

Technical info refers to models with built-in air cooled condensing unit.

PACKAGING STANDARD [Wooden crate]			4	6	7	9	12	120	140	
External dimensions	Lenght	inch	36 5/8	51 31/22	57 3/32	69 5/8	87 13/32	51 31/22	57 3/32	
	Depth x Height	inch	27 9/16 x 55 1/8				33 15/32 x 55 1/8			
Gross weight		lb	172	242	276	330	423	276	330	

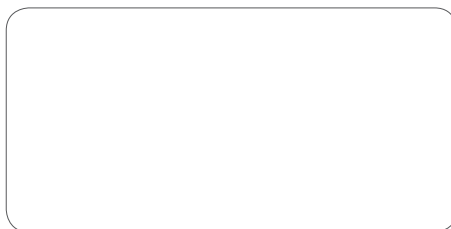

Dealer

Carpigiani North America ISA S.p.A.

3760 Industrial Drive
Winston-Salem
NC 27105
www.carpigiani-usa.com

Via Madonna di campagna, 123
06083 Bastia Umbra (PG)
Italy
T. +39 075 801 71
F. +39 075 800 09 00
E. customerservice@isaitaly.com
www.isaitaly.com